

HOBO® Pro v2 (U23-00x) Manual



HOBO Pro v2 U23-001 shown

The HOBO Pro v2 logger's environmentally rugged case is designed for years of reliable use in outdoor applications. It has enough memory to record over 42,000 12-bit measurements. The U23-001 and U23-002 models also feature user-replaceable RH sensors.

The logger uses an optical USB communications interface (via a compatible shuttle or base station) for launching and reading out the logger. The optical interface allows the logger to be offloaded without compromising the electronics. The USB compatibility allows for easy setup and fast downloads.

HOBO Pro v2 Logger

Models: U23-001
 U23-002
 U23-003
 U23-004

Included Items:

- Clamp and mounting screws
- UV protective cap

Required Items:

- Coupler (COUPLER2-E) with USB Optic Base Station (BASE-U-4) or HOBO Waterproof Shuttle (U-DTW-1)
- HOBOWare Pro 2.2.1 or later

Accessories:

- RH sensor replacement kit for U23-001 (HUM-RHPCB-1)
- RH sensor replacement kit for U23-002 (HUM-RHPCB-2)
- Replacement cable/sensor for U23-002 (CABLE-U23-002)
- Replacement UV protective caps (U23-CAP)

Specifications

Temperature Sensor

Operation Range	Internal sensor: -40 to 70°C (-40 to 158°F) U23-002 external temperature sensor: -40 to 70°C (-40 to 158°F) U23-003 and U23-004 external sensors: -40 to 100°C (-40 to 212°F), with tip and cable immersion in fresh water up to 50°C (122°F) for one year
Accuracy	±0.21°C from 0° to 50°C (±0.38°F from 32° to 122°F); see Plot A
Resolution	0.02°C at 25°C (0.04°F at 77°F); see Plot A
Response Time (Typical to 90%)	U23-001 internal sensor: 40 minutes in air moving 1 m/sec U23-002 external temperature sensor: 5 minutes in air moving 1 m/sec U23-003 and U23-004 external sensors: 3 minutes in air moving 1 m/sec; 30 seconds in stirred water
Stability (Drift)	< 0.1°C (0.18°F) per year

Relative Humidity Sensor (U23-001, U23-002 only)

Operation Range	0 to 100% RH, -40° to 70°C (-40° to 158°F) Exposure to conditions below -20°C (-4°F) or above 95% RH may temporarily increase the maximum RH sensor error by an additional 1%
Accuracy	±2.5% from 10% to 90% RH (typical), to a maximum of ±3.5% including hysteresis. See Plot B for full range.
Resolution	0.03%
Response Time (Typical to 90%)	U23-001: 40 minute in air moving 1 m/sec with protective cap U23-002: 5 minutes in air moving 1 m/sec with protective cap
Stability (Drift)	<1% per year typical

Logger

Operation Range	-40° to 70°C (-40° to 158°F)
Real-time Clock	±1 minute per month 0° to 50°C (32° to 122°F)
Battery	1/2 AA, 3.6 Volt lithium, user-replaceable (HP-B)
Battery Life (Typical Use)	3 years with 1 minute or greater logging interval
Memory (Non-Volatile)	64K bytes memory (approx. 21,000 temperature and RH measurements)
Materials	All models: ASA styrene polymer housing and mounting clamp; polypropylene protective cap; Buna-N o-ring(s); U23-001, U23-002 only: ASA styrene polymer RH sensor cap; modified hydrophobic polyethersulfone membrane

Specifications (continued)

Cables	U23-001: No cables U23-002: One 184 cm (6 ft) PVC cable; sensor diameter 1 cm (0.38 in.) U23-003: Two 184 cm (6 ft) PVC cables; sensor diameter 0.5 cm (0.20 in.) U23-004: One 184 cm (6 ft) PVC cable; sensor diameter 0.5 cm (0.20 in.)
Environmental Rating	Electronics housing is NEMA 6P equivalent (tolerant of brief submergence); Units with RH sensors are NEMA 4 equivalent (splash-resistant)
Launch Modes	Immediate start; delayed start
Logging Interval	Fixed-rate or multiple logging intervals, with up to 8 user-defined logging intervals and durations; logging intervals from 1 second to 18 hours
Offload Modes	Offload while logging; stop and offload
Battery Indication	Battery voltage can be viewed in status screen and optionally logged in datafile. Low battery indication in datafile.
Weight	U23-001: 57 g (1.5 oz); U23-002: 118 g (3.1 oz); U23-003: 138 g (3.7 oz); U23-004: 102 g (2.7 oz)
Dimensions	Housing measures 10.2 × 3.8 cm (4.0 × 1.5 in.)
NIST Certificate	Temperature certificate available for additional charge
	The CE Marking identifies this product as complying with all relevant directives in the European Union (EU).

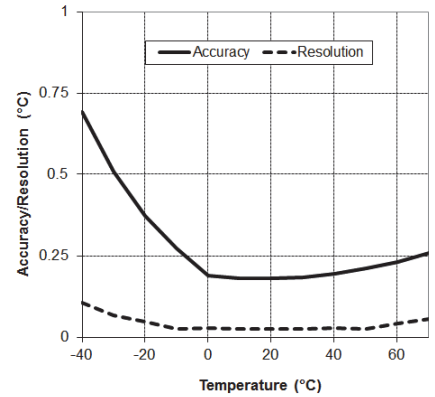

Plot A

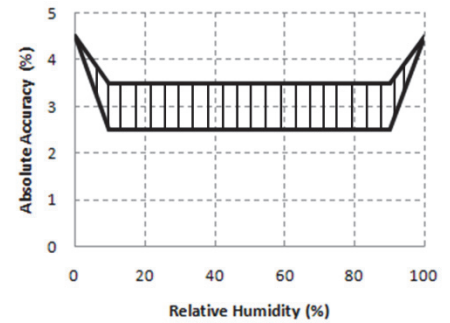

Plot B

Connecting the Logger

The HOBO Pro v2 requires a coupler (COUPLER2-E) and USB-Optic Base Station (BASE-U-4) or HOBO Waterproof Shuttle (U-DTW-1) to connect to the computer.

IMPORTANT: USB 2.0 specifications do not guarantee operation outside the range of 0°C (32°F) to 50°C (122°F).

1. Install the HOBOWare logger software on your computer before proceeding.
2. Follow the instructions that came with your base station or shuttle to attach the base station or shuttle to a USB port on the computer.
3. Make sure the logger's communications window is clean and dry. (Use a clean, nonabrasive cloth, if necessary.) If the logger is damp, wipe off excess moisture.
4. Attach the coupler to the base station or shuttle, then insert the logger into the coupler with the ridge on the logger aligned with the ridge on the coupler.
5. If you are using the HOBO Waterproof Shuttle, briefly press the coupler lever to put the shuttle into base station mode.
6. If the logger has never been connected to the computer before, it may take a few seconds for the new hardware to be detected by the computer.
7. Use the logger software to launch the logger, check the logger's status, read it out, stop it manually with the software, or let it continue to record data until the memory is full. Or, use the HOBO Waterproof Shuttle to read out and relaunch the logger in the field.

Refer to the software user's guide for complete details on launching, reading out, and viewing data from the logger.

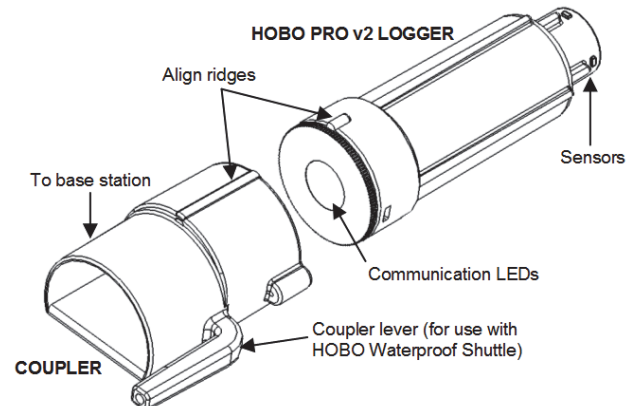

Note: The first time you launch the logger, the deployment number will be greater than zero. Onset launches the loggers to test them prior to shipping.

Operation

A light (LED) in the communications window of the logger confirms logger operation. (In brightly lit areas, it may be necessary to shade the logger to see the LED blink.) This table explains when the light blinks during logger operation:

When:	The OK Light Does This:
The logger is logging	Blinks once every one to four seconds (the shorter the logging interval, the faster the light blinks); blinks when logging a sample.
The logger is awaiting a start because it was launched in Start At Interval or Delayed Start mode	Blinks once every eight seconds until logging begins

Sample and Event Logging

The logger can record two types of data: samples and events. Samples are the sensor measurements recorded at each logging interval (for example, temperature every minute). Events are independent occurrences triggered by a logger activity, such as Bad Battery or Host Connected. Events help you determine what was happening while the logger was logging.

The logger stores 64K of data, and can record over 42,000 12-bit measurements.

Deploying and Protecting the Logger

- To clean the logger's case, use a sponge with warm, soapy water.
- Use the included clamp to mount the logger to a surface. The clamp has two holes for the screws, 44 mm (1.7 inches) apart.

The clamp is slightly tapered to accommodate the logger. Install the clamp so the logger is oriented with the communication window facing up or to the side. This will prevent condensation from pooling on the sensor or cable grommet.

- A solar radiation shield is required if the logger with internal sensors or the external sensors will be in sunlight at any time.

- The U23-001 logger must be mounted horizontally. If the U23-001 logger is being deployed in a solar radiation shield, it must be mounted horizontally as shown in this diagram.

- When deploying a U23-002 logger, the sensor must be mounted vertically. If the sensor is being deployed in a solar radiation shield, it must be mounted vertically as shown in this diagram.

- If the logger housing will be in sunlight, slide the included protective cap over the logger communication window to protect the window against UV light.

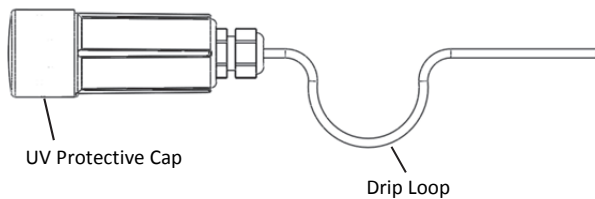

- When mounting the logger, be sure to attach the logger so the logger cable is not being pulled. Also leave about 5 cm (2 inch) of drip loop in the cable where it comes out of the logger (as shown in the above diagrams) to prevent water from entering the logger housing.

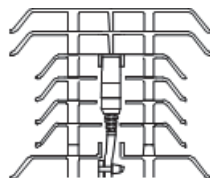
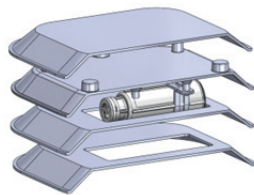
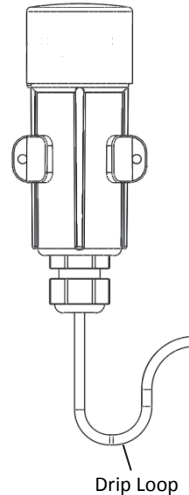

- If there are chewing rodents or other cable hazards present, the sensor cable should be protected in conduit.
- Periodically inspect the three desiccant packs located in the logger cap. If they are not bright blue, dry them following the instructions below.

To dry a desiccant pack, remove it from the logger cap and leave in a warm ($\leq 70^{\circ}\text{C}$ (158°F)), dry location until the bright blue color is restored. (Refer to the "Battery" section for instructions on removing and replacing the logger cap.)

If a desiccant pack remains pink and will not turn blue, replace it with a new desiccant pack (DESICCANT1)

Replacing the RH Sensor

The RH sensor (on models U23-001 and U23-002) is protected by an ASA styrene polymer cap and a modified hydrophobic polyethersulfone fluid barrier membrane that allows vapor to penetrate while protecting the sensor from condensation.

RH sensor performance may degrade over time. To replace the RH sensor in your logger, refer to the diagram and instructions for your logger.

U23-001 RH Sensor Replacement Steps

- Turn the RH sensor cap counter-clockwise slightly and pull to remove it. Discard the sensor cap, membrane, and o-ring. Clean the sensor end of the logger.

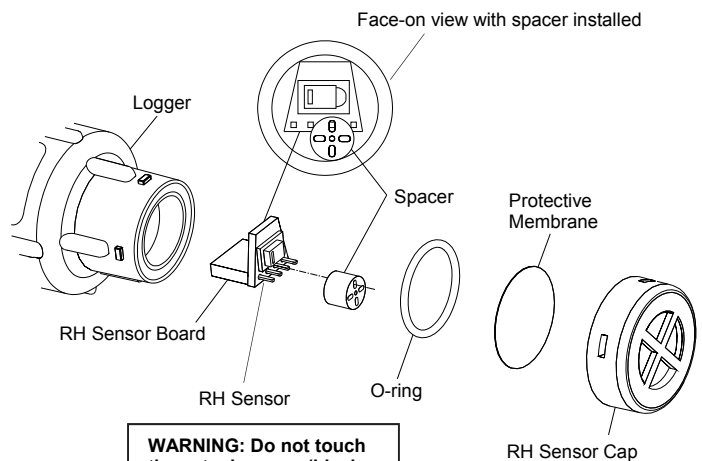

- There may be a spacer installed on the RH Sensor Board. Remove and discard the spacer.
- Note the orientation of the small circuit board containing the RH sensor. With a pair of needle-nose pliers, grip the sensor board pins. Pull out and discard the board.
- Use needle-nose pliers to hold the pins on the new sensor board, push the board gently but firmly and install it in the same orientation as the old board. Make sure it engages with the pins inside the logger housing. Do not touch the sensor itself; only touch the sides of the board.
- Install the new spacer on the sensor board by placing the spacer onto the third pin from the left (use the topmost hole on the spacer instead of the center hole).

6. Make sure the o-ring is clean and seated properly, and set the protective membrane on top (either side can face up).
7. Put the sensor cap back on. Push down and turn it slightly clockwise to close it securely. Do not force it. If the cap does not go on easily, the sensor may be installed incorrectly. Check the sensor orientation and try again.
8. Check logger status in HOBOWare to verify the RH reading.

U23-002 RH Sensor Replacement Steps

1. Grasp the cap and membrane and pull firmly. Discard them.
2. Note the orientation of the small circuit board containing the RH sensor. Pull it out and discard it.

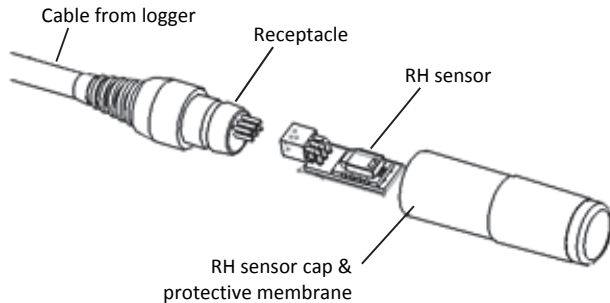

3. Holding the sides of the board only, push gently but firmly to install the new sensor (HUM-RHPCB-2) in the same orientation. **WARNING:** Do not touch the actual sensor (black chip) itself; doing so may compromise accuracy.
4. Put the new sensor cap and membrane on. Do not force the cap. If it does not go on easily, the sensor may be installed backwards. Reverse the sensor and try again.

Battery

Typical battery life is about three years. Actual battery life is a function of the number of deployments, logging interval, and operation/storage temperature of the logger. To obtain a three-year battery life, use a logging interval of one minute or greater, and operate and store the logger at temperatures between 0° and 40°C (32° and 104°F).

Frequent deployments with logging intervals of less than one minute, and continuous storage/operation at temperatures above 40°C, will result in significantly lower battery life. For example, continuous logging at a one-second logging interval will result in a battery life of approximately one month.

The logger can report and log its own battery voltage. If the battery falls below 3.1 V, the logger will record a “bad battery” event in the datafile. If the datafile contains “bad battery” events, or if logged battery voltage repeatedly falls below 3.3 V, the battery is failing and should be replaced before the next deployment. To change the battery:

1. Turn slightly counter-clockwise and pull to remove the protective cap. Loosen the cable grommet on the opposite end, if the logger has an external sensor.

2. Carefully pull out the circuit board containing the battery. (If the logger has an external sensor, you will probably find it easier to push the cable(s) into the case to push the circuit board out.)
3. Examine the desiccant packs that were packed into the case. If the desiccant is not bright blue, put the desiccant packs in a warm, dry place until the blue color is restored.

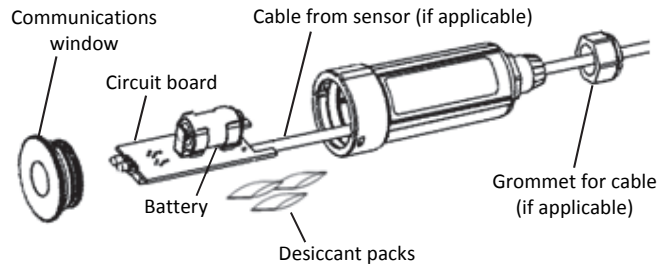

4. Install a new 1/2 AA, 3.6 Volt lithium battery (part # HP-B). The negative end of the battery must face towards the communication LEDs.
5. Use a clean, dry cloth to wipe away any moisture inside the case.
6. Push the board and the desiccant packs back into the case, taking care not to bend the communication LEDs. Align the board with the grooves inside the case. (If you try to put the board in upside-down, the battery will get in the way.)
7. Make sure O-ring on the protective cap is still in place. It should not be pinched, twisted, or trapping dirt or lint, which could interfere with the protective cap. If you are replacing it with a new O-ring from an RH sensor replacement kit, discard the old O-ring and place the new one into the same groove on the communications window. Apply a small dot of lubricant from the grease packet included in the kit on the O-ring. Spread the lubricant around the O-ring just enough to moisten it while avoiding getting it on the communications window.
8. Line up the bumps on the protective cap with the notches in the logger’s case. Push and turn the cap slightly clockwise. Pull the slack in the sensor cable(s) if applicable. Hand-tighten the grommet and then turn an additional half turn with a wrench (do not force).

WARNING: Do not cut open, incinerate, heat above 100°C (212°F), or recharge the lithium battery. The battery may explode if the logger is exposed to extreme heat or conditions that could damage or destroy the battery case. Do not dispose of the logger or battery in fire. Do not expose the contents of the battery to water. Dispose of the battery according to local regulations for lithium batteries.