

HOBO® 4-Channel Thermocouple Data Logger (UX120-014M) Manual



The HOBO 4-Channel Thermocouple data logger records temperature in indoor environments using up to four J, K, T, E, R, S, B, or N type thermocouple sensors (sold separately). The logger also has an internal 10K thermistor for cold-junction compensation of the thermocouple output. The four thermocouple channels have a 20-bit resolution while the internal 10K thermistor has a 12-bit resolution. Using HOBOWare®, you can easily configure the logger alarm to trip for specific high or low temperatures. Or, you can set up burst logging in which the logger records data at a different interval during certain conditions. The logger can also calculate minimum, maximum, average, and standard deviation statistics. This easy-to-use data logger has a built-in LCD screen to monitor temperature, logging status, battery use, and memory consumption in between readouts.

Specifications

HOBO 4-Channel Thermocouple Data Logger

UX120-014M

Included Items:

- Command™ strip
- Double-sided tape
- Hook & loop strap
- Two AAA 1.5V alkaline batteries

Required Items:

- HOBOWare 3.5 or later
- USB cable (included with software)
- Thermocouple sensor type J, K, T, E, R, S, B, or N

Thermocouple

Type	Range	Accuracy	Resolution
J	-210° to 760°C (-346° to 1,400°F)	±0.6°C (±1.08°F) ± thermocouple probe accuracy	0.03°C (0.06°F)
K	-260° to 1,370°C (-436° to 2,498°F)	±0.7°C (±1.26°F) ± thermocouple probe accuracy	0.04°C (0.07°F)
T	-260° to 400°C (-436° to 752°F)	±0.6°C (±1.08°F) ± thermocouple probe accuracy	0.02°C (0.03°F)
E	-260° to 950°C (-436° to 1,742°F)	±0.6°C (±1.08°F) ± thermocouple probe accuracy	0.03°C at (0.05°F)
R	-50° to 1,550°C (-58° to 2,822°F)	±2.2°C (±3.96°F) ± thermocouple probe accuracy	0.08°C (0.15°F)
S	-50° to 1,720°C (-58° to 3,128°F)	±2.2°C (±3.96°F) ± thermocouple probe accuracy	0.08°C (0.15°F)
B	550° to 1,820°C (1,022° to 3,308°F)	±2.5°C (±4.5°F) ± thermocouple probe accuracy	0.1°C (0.18°F)
N	-260° to 1,300°C (-436° to 2,372°F)	±1.0°C (±1.8°F) ± thermocouple probe accuracy	0.06°C (0.11°F)

Internal 10K Thermistor (Temperature)

Range	-20° to 70°C (-4° to 158°F)
Accuracy	±0.21°C from 0° to 50°C (±0.38°F from 32° to 122°F), see Plot A
Resolution	0.024°C at 25°C (0.04°F at 77°F); see Plot A
Drift	<0.1°C (0.18°F) per year

Logger

Logger Operating Range	Logging: -20° to 70°C (-4° to 158°F); 0 to 95% RH (non-condensing); Launch/Readout: 0° to 50°C (32° to 122°F) per USB specification
Logging Rate	1 second to 18 hours, 12 minutes, 15 seconds
Logging Modes	Normal, burst, or statistics
Memory Modes	Wrap when full or stop when full
Start Modes	Immediate, push button, date & time, or next interval
Stop Modes	When memory full, push button, or date & time
Restart Mode	Push button
Time Accuracy	±1 minute per month at 25°C (77°F), see Plot B
Battery Life	1 year, typical with logging rate of 1 minute and sampling interval of 15 seconds or greater
Battery Type	Two AAA 1.5V alkaline batteries, user replaceable
Memory	4 MB (1.9 million measurements, maximum)

Specifications (continued)

Logger (continued)

Download Type	USB 2.0 interface
Full Memory Download Time	Approximately 1.5 minutes
LCD	LCD is visible from 0° to 50°C (32° to 122°F); the LCD may react slowly or go blank in temperatures outside this range
Size	10.8 x 5.41 x 2.54 cm (4.25 x 2.13 x 1 in.)
Weight	107.5 g (3.79 oz)
Environmental Rating	IP50
	The CE Marking identifies this product as complying with all relevant directives in the European Union (EU).

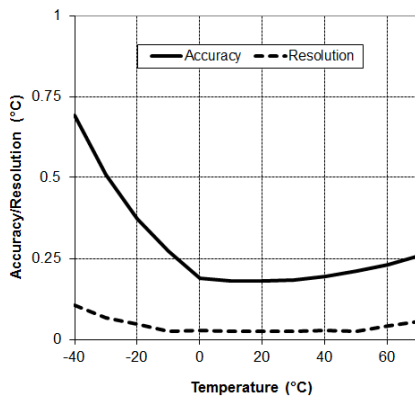

Plot A: Internal Temperature Accuracy & Resolution

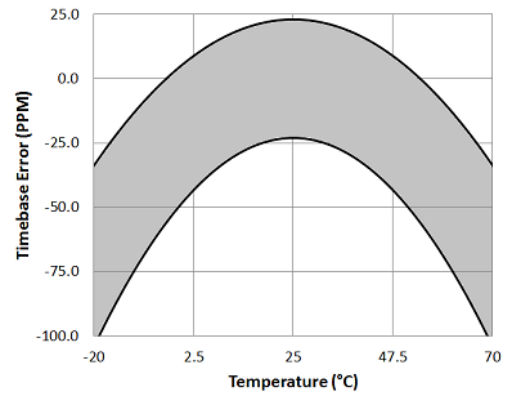

Plot B: Time Accuracy

Logger Components and Operation

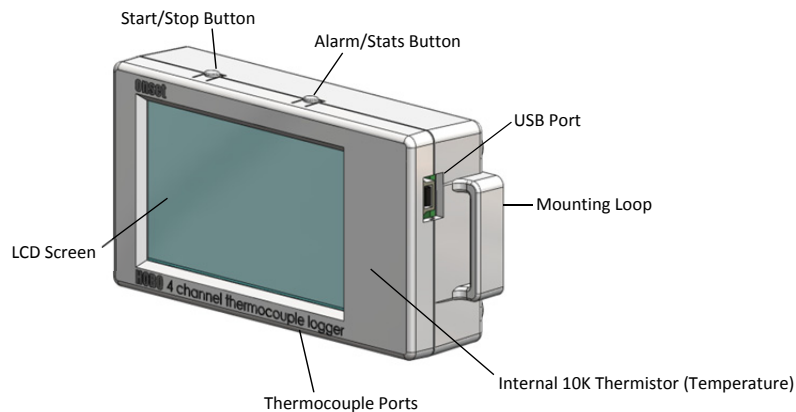

Start/Stop Button: Press this button for 3 seconds to start or stop logging data, or to resume logging. This requires configuring the logger in HOBOWare with a push button start or stop, and with “Resume logging on next button push” selected (see *Setting up the Logger*). You can also press this button for 1 second to record an internal event (see *Recording Internal Logger Events*) or to turn the LCD screen on if the option to turn off the LCD has been enabled (see *Setting up the Logger*).

Alarm/Stats Button: Use this button to clear a tripped alarm (see *Setting up Alarms*) or to switch between statistics, alarm

readings, the current sensor reading, and the internal temperature reading (if enabled in HOBOWare).

Mounting Loops: Use the two mounting loops (only one visible in the diagram) to mount the logger with the hook-and-loop strap (see *Mounting the Logger*).

Internal 10K Thermistor (Temperature): The internal 10K thermistor (not visible in the diagram) measures ambient temperature, if the channel is configured to log in HOBOWare (see *Setting up the Logger*).

Thermocouple Ports: Use these ports to connect thermocouple sensors (see *Connecting Thermocouple Sensors*).

USB Port: Use this port to connect the logger to the computer or the HOBO U-Shuttle via USB cable (see *Setting up the Logger and Reading Out the Logger*).

LCD Screen: This logger is equipped with an LCD screen that displays details about the current status. This example shows all symbols illuminated on the LCD screen followed by definitions of each symbol in the table below.

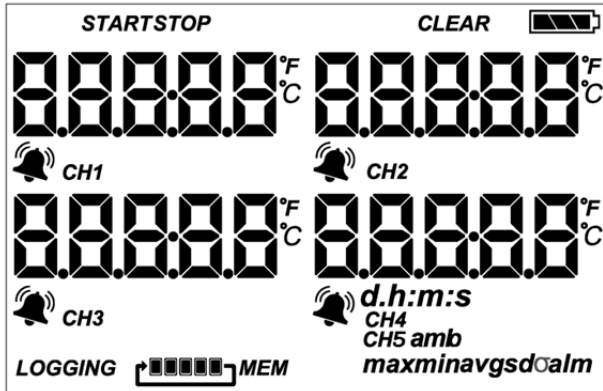

LCD Symbol	Description
START	The logger is waiting to be launched. Press and hold the Start/Stop button for 3 seconds to launch the logger.
STOP	The logger has been launched with push button stop enabled; press and hold the Start/Stop button for 3 seconds to stop the logger. Note: If you also launched the logger with a push button start, this symbol will not appear on the display for 30 seconds.
CLEAR	An alarm is ready to be cleared. This will only appear if “Cleared with button press” was selected in the HOBOWare alarm settings. Press the Alarm/Stats button for 3 seconds to clear the alarm.
	The battery indicator shows the approximate battery power remaining.
	This is an example of a temperature reading. Temperature units are determined by the settings in HOBOWare. To switch between Celsius and Fahrenheit, change the Display Preferences in HOBOWare before launching the logger.
	A sensor reading is above or below the high or low alarm that you configured. Press and release the Alarm/Stats button until the “alm” symbol (described later in this chart) is displayed on the screen. This symbol at left will clear depending on how alarms were configured in HOBOWare. If the alarm was configured to clear when the logger is relaunched, this symbol will remain on the LCD. Otherwise, it will clear when the sensor reading is back within the alarm limits or by pressing the Alarm/Stats button for 3 seconds. Note that if an alarm symbol appears next to the “CH5 amb” symbol, it applies to the fourth thermocouple channel and not the internal 10K thermistor (temperature) channel, which does not support alarm functionality.

LCD Symbol	Description
CH1	This is the channel number associated with the thermocouple reading (channel 1 for this example). Up to four channels are visible at one time. Press the Alarm/Stats button for 1 second to cycle through any available statistics and then to the fifth channel, which is the ambient temperature (“CH5 amb”) being logged by the internal 10K thermistor (if enabled in HOBOWare).
05:38 m:s	The logger has been configured to start logging on a particular date/time. The display will count down in days, hours, minutes, and seconds until logging begins. In this example, 5 minutes and 38 seconds remain until logging will begin.
LOGGING	The logger is currently logging.
MEM	The logger has been configured to stop logging when memory fills. The memory bar indicates the approximate space remaining in the logger to record data. When first launched, all five segments in the bar will be empty. In this example, the logger memory is almost full (only one segment in the memory bar is empty).
MEM	The logger has been configured to never stop logging (wrapping). The logger will continue recording data indefinitely, with newest data overwriting the oldest data. When first launched, all five segments in the memory bar will be empty. In this example, the memory is full (all five segments are filled in) and new data is now overwriting the oldest data. This will continue until the logger is stopped or the battery runs out.
max min avg sd	These symbols show the maximum, minimum, average, and standard deviation values most recently calculated by the logger (if the logging mode has been set to Statistics in HOBOWare). Press the Alarm/Stats button for 1 second to cycle through each of the available statistics and then to the channel 5 thermistor reading (if enabled), and then ultimately back to the current thermocouple readings (or to the alarm value if applicable).
alm	This is the sensor reading that tripped the alarm. Press the Alarm/Stats button to view this reading. Press the Alarm/Stats button again to cycle through any statistics, then to the channel 5 thermistor reading (if enabled), and ultimately back to the current thermocouple readings.
Load	The launch settings are being loaded onto the logger from HOBOWare. Do not disconnect the USB cable during this process.
Err	An error occurred while loading the launch configurations onto the logger from HOBOWare. Make sure the USB cable is connected to both the logger and the computer and try launching again.
Stop	The logger has been stopped with HOBOWare or because the memory is full.

Notes:

- You can disable the LCD screen when logging. Select “Turn LCD off” when setting up the logger as described in the next section. When this option is enabled, you can still temporarily view the LCD screen by pushing the Start/Stop button for 1 second. The LCD will then remain on for 10 minutes.
- The LCD screen refreshes every 15 seconds while logging regardless of the logging interval selected in HOBOWare.

If you choose a logging interval less than 15 seconds, the data will be recorded at the faster interval, but the temperature readings will only be updated on the screen every 15 seconds.

- When the logger has stopped logging, the LCD screen will remain on until the logger is offloaded to a computer or HOBO U-Shuttle (unless launched with the “Turn LCD off” option). Once the logger has been offloaded and disconnected from the computer, the LCD will turn off automatically after 2 hours. The LCD will turn back on the next time the logger is connected to the computer.

Setting up the Logger

Use HOBOWare to set up the logger, including setting alarms, selecting the options to start and stop logging, and choosing a logging mode.

1. **Install the batteries.** See *Battery* for more information.
2. **Connect the logger and open the Launch Logger window.** To connect the logger to a computer, use the USB cable provided. Click the Launch icon on the HOBOWare toolbar or select Launch from the Device menu.

Important: USB 2.0 specifications do not guarantee operation outside the range of 0°C (32°F) to 50°C (122°F).

3. **Select the thermocouple types.** Under Configure Sensors to Log, select all the thermocouple channels that will be logged and select the correct type of thermocouple for each one as shown in the following example. Type labels for each thermocouple if desired.

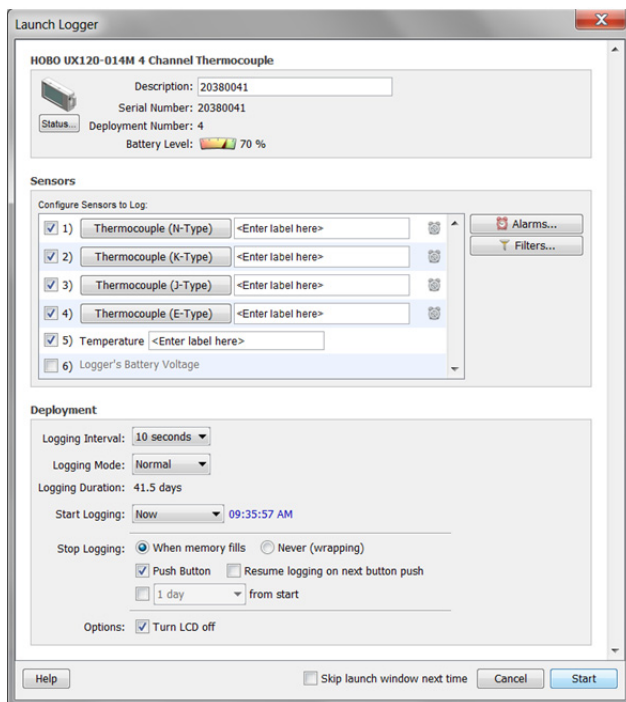

4. **Select the internal 10k thermistor (temperature) channel to log (optional) and type a label if desired.** This internal 10K thermistor measures ambient temperature and is used for cold-junction compensation of the thermocouple output.

Important: Cold-junction compensation is always performed on the thermocouple measurements even if the internal 10k thermistor (temperature) channel is not selected for logging.

5. **Set up alarms (optional).** Click the Alarms button if you want to configure an alarm to trip when the temperature is above or below a value you specify. See *Setting up Alarms* for details.
6. **Configure filters (optional).** Click the Filters button to create additional filtered data series. Any filtered series will be available automatically upon reading out the logger.
7. **Select the Logging Interval.** Select a logging interval from 1 second to a maximum of 18 hours, 12 minutes, and 15 seconds.
8. **Select the Logging Mode:**
 - **Normal.** In Normal mode, data will always be recorded at the regular logging interval set in the previous step. This is the default setting.
 - **Burst.** In Burst mode, logging will occur at a different interval when a specified condition is met. See *Burst Logging* for more information.
 - **Statistics.** In Statistics mode, maximum, minimum, average, and standard deviation statistics are calculated for the temperature during logging, sampling at an interval you specify. See *Statistics* for more information.
9. **Choose when to start logging:**
 - **Now.** Logging begins immediately.
 - **At Interval.** Logging will begin at the next even interval as determined by the selected logging interval.
 - **On Date/Time.** Logging will begin at a date and time you specify.
 - **Push Button.** Logging will begin once you press the Start/Stop logging button for 3 seconds.
10. **Choose when to stop logging:**
 - **When Memory Fills.** Logging will end once the logger memory is full.
 - **Never (Wrapping).** The logger will continue recording data indefinitely, with newest data overwriting the oldest.
 - **Push Button.** Logging will end once you press the Start/Stop logging button for 3 seconds. If you select Push Button, you also have the option to select “Resume logging on next button push.” Select this if you want to be able to start and stop logging at any time during the deployment by pushing the Start/Stop button on the logger. Note that if you also choose Push Button to start logging, then you will not be able to stop logging until 30 seconds after logging begins.
 - **Specific Stop Time.** Logging will end at a date and time you specify. Note that if you also configure the logger for a Push Button stop and to “Resume logging on next button push,” then the logger will stop logging at the date you select regardless of how many times you stop and restart the logger with the Start/Stop button.

11. Choose whether to keep the LCD on or off. By default, the LCD will always remain on while logging. If you select the “Turn LCD off” checkbox, the LCD will not show the current readings, status, or other information while the logger is logging. You will, however, be able to temporarily turn the LCD screen on by pressing the Start/Stop button for 1 second if you select this option.

12. Click the Start button to launch the logger. Disconnect the logger from the computer and deploy it using the mounting materials (see *Mounting the Logger*). After logging begins, you can read out the logger at any time (see *Reading Out the Logger* for details).

Important note when using the HOBO U-Shuttle (U-DT-1) with a HOBO 4-Channel Thermocouple logger (UX120-014M): If the HOBO 4-Channel Thermocouple logger is configured to log multiple channels with several statistics selected or with burst logging enabled, the HOBO U-Shuttle can report erroneous battery readings and may result in unexpected behavior. Only use the shuttle with the HOBO 4-Channel Thermocouple logger if you plan on minimal logging (such as logging thermocouple channels only or two channels plus statistics logging). It is highly recommended that you test your logger configuration with the shuttle before deploying it to be sure the battery readings are as expected and the offload works properly.

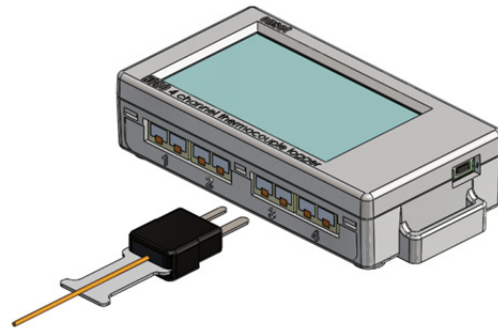

Setting up Alarms

You can set an alarm to trip when a sensor reading rises above or falls below a specified value on any of the thermocouple channels. To set an alarm:

1. Click the Alarms button from the Launch Logger window. If the Alarms button is disabled, make sure the Logging Mode is not set to Burst. (Alarms can only be configured if the logger is in Normal or Statistics mode.)
2. In the Configure Alarms window, select a thermocouple from the list.
3. Select the High Alarm checkbox if you want an alarm to trip when the temperature rises above the high alarm value for that thermocouple. Type the reading next to the High Alarm checkbox or drag the red upper slider in the Configure Alarms window.

Connecting Thermocouple Sensors

The logger can accept up to four standard thermocouple sensor of the appropriate type with standard thermocouple subminiature connectors.

ANSI Standard Thermocouple Color Coding

Type-J	Iron-Constantan	Black
Type-K	Chromel-Alumel	Yellow
Type-S	Platinum-Rhodium	Green
Type-T	Copper-Constantan	Blue
Type-E	Chromel-Constantan	Purple
Type-R	Platinum-Rhodium	Green
Type-B	Platinum-Rhodium	Gray
Type-N	Nicrosil-Nisil	Orange

Refer to <http://www.omega.com/techref/colorcodes.html> for additional details on color coding.

If the thermocouple has stripped-wire ends, male subminiature connectors with screw terminals are available. You must use the matching type of subminiature connector for the thermocouple you are using.

Note that the subminiature connectors have one pin (negative terminal) that is wider than the other (positive terminal). Make sure the plug is inserted into the jack correctly as shown. Also be sure to connect the correct thermocouple into the appropriate channel as defined in HOBOware.

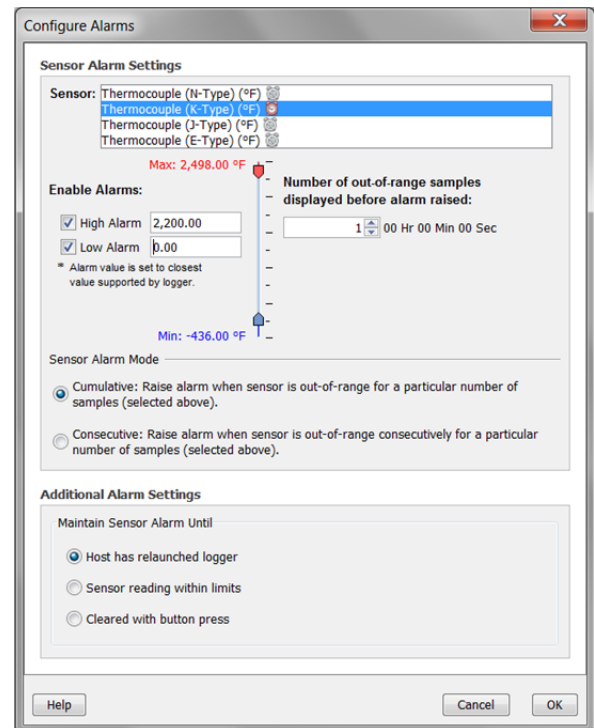

4. Select the Low Alarm checkbox if you want an alarm to trip when the temperature falls below the low alarm value for that thermocouple. Type the reading next to the Low Alarm checkbox or drag the blue lower slider.
5. Set the “Number of out-of-range samples displayed before alarm is raised,” which is the number of sensor readings needed to trigger each alarm. The time next to the “Number of out-of-range...” field indicates the amount of time it will

take for the alarm to trip based on the number you entered in that field and the 15-second LCD refresh rate.

6. Select either Cumulative or Consecutive for the Sensor Alarm Mode. If you select cumulative, the alarm will trip after a specific number of samples (as set in the previous step) are outside the limits (the high or low samples do not need to be consecutive). If you select Consecutive, the alarm will trip after a specific number of samples (as set in the previous step) outside the limits are displayed in a row.
7. Repeat steps 2 through 6 for any additional thermocouple sensors.
8. Choose how long the logger should maintain the sensor alarm once it has tripped. Select "Host has relaunched logger" if you want the alarm to remain visible on the LCD until the next time you relaunch the logger. Select "Sensor reading within limits" if you want the alarm to clear once the sensor reading returns to the normal range between the high and low alarm limits. Select "Cleared with button press" if you want the alarm to remain on until you press the Alarm/Stats button on the logger.
9. Click OK to save alarm settings.

Notes:

- Once the logger is launched, alarms will trip as determined by these settings. Logger alarms will display on the LCD screen. Note that the alarm limits are only checked when the logger's LCD screen refreshes every 15 seconds.
- The actual values for the high and low alarm limits are set to the closest values supported by the logger based on the thermocouple type. In addition, alarms can trip or clear when the sensor reading is within the resolution specification for each thermocouple type. This means the value that triggers the alarm may differ slightly than the value entered.
- When you read out the logger, high and low alarm levels will be displayed on the plot along with "Chan <#> Alarm Tripped" and "Chan <#> Alarm Cleared" events showing when the temperature alarm tripped and cleared. The "Chan <#> Alarm Cleared" event contains the value that was furthest out of range for the sensor before the alarm cleared (see the Points table for the actual value).
- Alarms can only be configured on thermocouple channels; they are not available for the internal 10K thermistor (temperature) channel.

Burst Logging

Burst logging is a logging mode that allows you to set up more frequent logging when a specified condition is met. For example, let's say the logger is recording data at a 5-minute logging interval and burst logging is configured to log every 10 seconds on one thermocouple when the temperature goes above 2,000°F (the high level) or falls below -200°F (the low level). This means the logger will record data every 5 minutes as long as the temperature remains between 2,000°F and -200°F on that channel. Once the temperature reaches 2,100°F, for example, the logger will switch to the faster logging rate and record data every 10 seconds until the temperature falls back below the high level (or 2,000°F in this case) on that channel. At that time, logging then resumes every 5 minutes at the normal

logging interval. Similarly, if the temperature falls to -250°F on that channel, for example, then the logger would switch to burst logging mode again and record data every 10 seconds. Once the temperature rises back to -200°F, the logger will then return to normal mode, logging every 5 minutes. To set up burst logging:

1. Select Burst for Logging Mode in the Launch Logger window. If Burst has already been configured for this logger, click the Edit button in the Launch Logger window.
2. In the Burst Logging window, select a thermocouple from the list.

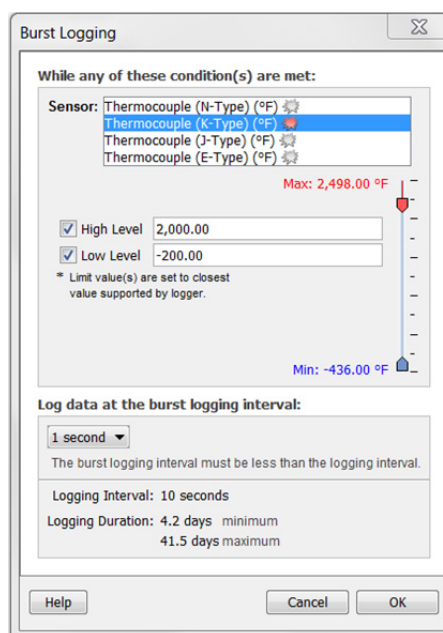

3. Select the High Level checkbox if you want to set up a condition in which burst logging will occur when the sensor reading rises above the high level value. Type in the value or drag the red upper slider.
4. Select the Low Level checkbox if you want to set up a condition in which burst logging will occur when the sensor reading falls below the low level value. Type in the value or drag the blue lower slider.
5. Repeat steps 2 through 4 for any additional thermocouple sensors.
6. Set the burst logging interval, which must be less than the logging interval. Select either a preset burst logging interval or select Custom and enter your own interval. Keep in mind that the more frequent the burst logging rate, the greater the impact on battery life and the shorter the logging duration.
7. Click OK when done. This will return you to the Launch Logger window. Click the Edit button next to Logging Mode in the Launch Logger window to make additional changes.

Notes:

- Burst logging is available on the four thermocouple channels only; it is not available for the internal 10K thermistor (temperature) channel.
- Once the logger is launched, the high and low burst logging levels are only checked when the logger's LCD screen refreshes once every 15 seconds. Therefore, if you set the logging interval to less than 15 seconds and

the sensor reading falls outside the levels, the burst logging will not begin until the next 15-second refresh cycle.

- The actual values for burst logging levels are set to the closest values supported by the logger based on the thermocouple type. In addition, burst logging mode can begin or end when the sensor reading is within the resolution specification for each thermocouple type. This means the value that triggers the alarm may differ slightly than the value entered.
- Once the high or low condition clears, the logging interval time will be calculated using the last recorded data point in burst logging mode, not the last data point recorded in “normal mode.” For example, let’s assume the logger has a 10-minute logging interval and logged a data point at 9:05. Then, the high level was surpassed and burst logging began at 9:06. Burst logging then continued until 9:12 when the sensor reading fell back below the high level. Now back in normal mode, the next logging interval will be 10 minutes from the last burst logging point, or 9:22 in this case. If burst logging had not occurred, the next data point would have been at 9:15.
- A New Interval event will appear on the plot (if you select events for plotting in the Plot Setup window) each time the logger enters or exits burst logging mode.

Statistics

Statistics is a logging mode in which the logger calculates maximum, minimum, average, and standard deviation statistics during logging, recording the results at each logging interval based on samples taken at a rate you specify. This will result in up to four additional series per sensor that record the following information at each logging interval:

- The maximum, or highest, sampled value,
- The minimum, or lowest, sampled value,
- An average of all sampled values, and
- The standard deviation from the average for all sampled values.

For example, let’s say the logging interval is set to 5 minutes and the sampling interval is set to 30 seconds (with maximum, minimum, average, and standard deviation all enabled). Once logging begins, the logger will measure and record the actual sensor values every 5 minutes. In addition, the logger will take a sample every 30 seconds and temporarily store it in memory. The logger will then calculate the maximum, minimum, average, and standard deviation using the samples gathered over the previous 5-minute period and log the resulting value(s). When reading out the logger, this would result in 5 data series for each thermocouple channel: one thermocouple series (with data logged every 5 minutes) plus four maximum, minimum, average, and standard deviation series (with values calculated and logged every 5 minutes based on the 30-second sampling).

Note: Statistics are available on the four thermocouple channels only; they are not available on the internal 10K thermistor (temperature) channel.

To set up statistics:

1. Select Statistics for Logging Mode in the Launch Logger window. If Statistics has already been configured for this logger, click the Edit button in the Launch Logger window.
2. Click the Maximum, Minimum, Average, and Standard Deviation checkboxes for each of the statistics you want to calculate during logging. Note that Average is automatically enabled when selecting Standard Deviation. In addition, the more statistics you record, the shorter the logger duration and the more memory is required.
3. Set the sampling interval, which must be less than and a factor of the logging interval. Choose either a preset sampling interval or select Custom and enter your own sampling interval. Keep in mind that the more frequent the sampling rate, the greater the impact on battery life.

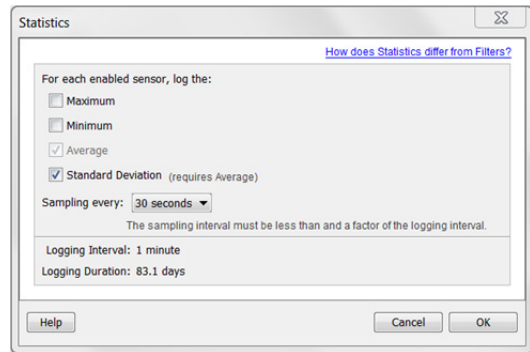

4. Click OK when done. This will return you to the Launch Logger window. Click the Edit button next to Logging Mode in the Launch Logger window to make additional changes.

Once logging begins, click the Alarm/Stats button on the logger to cycle through the current maximum, minimum, average, and standard deviation data on the LCD screen. You can plot the statistics series once you read out the logger.

Reading Out the Logger

There are two options for reading out the logger: connect it to the computer with a USB cable and read out it with HOBOWare, or connect it to a HOBO U-Shuttle (U-DT-1, firmware version 1.20m030 or higher) and then offload the data files from the U-Shuttle to HOBOWare. Refer to the HOBOWare Help for details.

Recording Internal Logger Events

The logger records the following internal events to track logger operation and status. You can plot these events in HOBOWare after reading out the logger and opening the data file.

Internal Event Name	Definition
Host Connected	The logger was connected to the computer.
Started	The Start/Stop button was pressed to begin logging.
Stopped	The logger received a command to stop recording data (from HOBOWare or by pushing the Start/Stop button).
Button Up/Button Down	The Start/Stop button was pressed for 1 second.

Internal Event Name	Definition
Bad Battery	The battery level dropped below 2.0 V (recorded even when the battery channel has been disabled).
Good Battery	The battery level rose to 2.75 V or above after a Bad Battery event was marked.
Chan <#> Alarm Tripped	A temperature alarm has tripped on that channel.
Chan <#> Alarm Cleared	A temperature alarm has cleared on that channel. This event also contains the value that was furthest out of range for the sensor before the alarm cleared.
New Interval	The logger has entered or exited burst logging mode.
Safe Shutdown	The battery level dropped below 1.85 V; the logger performs a safe shutdown.

Mounting the Logger

There are several ways to mount the logger using the materials included:

- Use the four built-in magnets on the back of the logger to mount it to a magnetic surface.
- Attach the Command strip to the back of the logger to mount it a wall or other flat surface.
- Use the double-sided tape to affix the logger to a surface.
- Insert the hook-and-loop strap through the mounting loops on both sides of the logger to mount it to a curved surface, such as a pipe or tubing.

Protecting the Logger

The logger is designed for indoor use and can be permanently damaged by corrosion if it gets wet. Protect it from condensation. If the message FAIL CLK appears on the LCD screen, there was a failure with the internal logger clock possibly due to condensation. Remove the batteries immediately and dry the circuit board.

Note: Static electricity may cause the logger to stop logging.

The logger has been tested to 8 KV, but avoid electrostatic discharge by grounding yourself to protect the logger. For more information, search for “static discharge” in the FAQ section on onsetcomp.com.

Battery Information

The logger requires two user-replaceable AAA 1.5V alkaline or optional lithium batteries for operation at the extreme ends of the logger operating range. Expected battery life varies based on the ambient temperature where the logger is deployed, the logging or sampling interval, frequency of offloading to the computer, number of channels that are active, if burst or statistics logging modes are active, and battery performance. New batteries typically last 1 year with logging intervals greater than 1 minute. Deployments in extremely cold or hot temperatures, a logging interval faster than 1 minute, or a

sampling interval faster than 15 seconds can impact battery life. Estimates are not guaranteed due to uncertainties in initial battery conditions and operating environment.

The logger can also be powered by the USB cable when the remaining battery voltage is too low for it to continue logging. Connect the logger to the computer, click the Readout button on the toolbar, and save the data as prompted. Replace the battery before launching the logger again.

To install or replace the batteries:

1. Open the battery door on the back of the logger.
2. Remove any old batteries.
3. Insert two new batteries observing polarity.
4. Reinsert the battery door and snap it back into place.

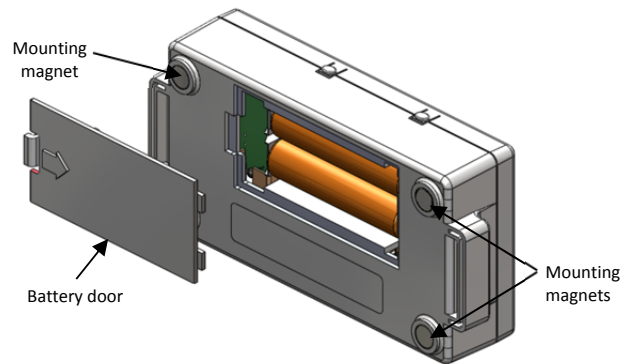

WARNING: If using optional lithium batteries, do not cut open, incinerate, heat above 85°C (185°F), or recharge the lithium batteries. The batteries may explode if the logger is exposed to extreme heat or conditions that could damage or destroy the batteries case. Do not dispose of the logger or batteries in fire. Do not expose the contents of the batteries to water. Dispose of the batteries according to local regulations for lithium batteries.

HOBOWare provides the option of recording the current battery voltage at each logging interval, which is disabled by default. Recording battery life at each logging interval takes up memory and therefore reduces logging duration. It is recommended you only record battery voltage for diagnostic purposes. Even with the channel disabled, a bad battery event will still be recorded.